

OUR FOOTPRINTS

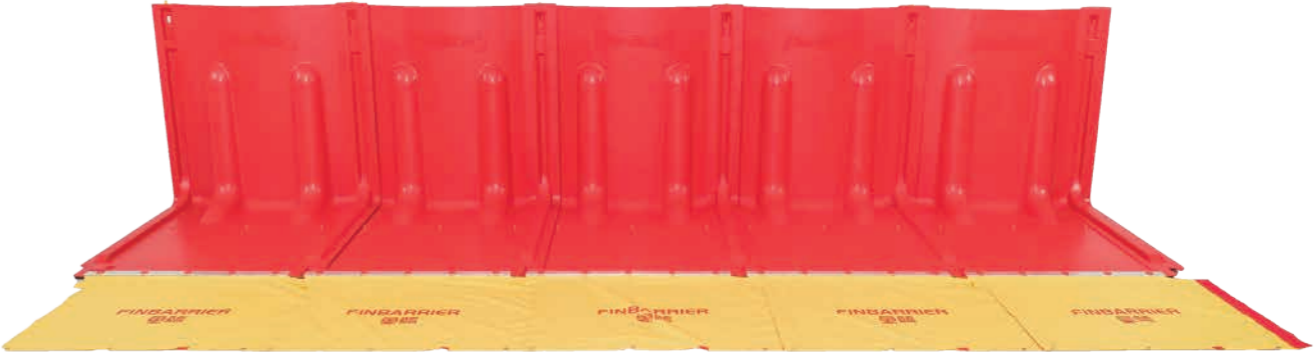

Denilco

FLOOD CONTROL PRODUCTS



Denilco

Tel.: +86-512-67582479
E-mail : sales@denilco.com
Web : en.denilco.com / www.wflood.com
Add. : No.275 Xinglong Road, SIP, Suzhou, Jiangsu, China

Denilco Environmental Technology (Suzhou) Co., Ltd.

ABOUT US

Established in 2017 and headquartered in Suzhou, Jiangsu Province, China, Denilco Environmental Technology (Suzhou) Co., Ltd. specialises in the research, development, and manufacturing of flood control equipment. With the changes of the climate, the increase of extreme weather leads to floods or urban storm water. Among the solutions, Denilco flood control barriers are more effective than sandbags which shows quicker response to flood, protect people and their properties from lost. Denilco flood control products are mainly used in municipal management, water drainage, construction, rail transit, plant property, emergency management and so on. We have collaborated with China's Ministry of Water Resources, Ministry of Transport, National Energy Administration, and Nanjing Hydraulic Research Institute to establish a joint research project for the development of 'L-shaped flood barriers'. To date, we have designed and developed over 30 distinct products, positioning us as the world's largest enterprise in flood control equipment design and development.

PRODUCT CATALOG

Combined flood prevention board	01
Finbarrier emergency flood control screen	06
Self-inflating sandbags	08
Aluminum flood barrier	10
Flood prevention pump with huge flow	12
Inflating flood tube	14
Sanitary sewer overflow stop	16



COMBINED FLOOD PREVENTION BOARD

Denilco combined Flood prevention board is designed to protect the city from sudden rainstorm and flood waterlogging. This device is a temporary flood control board which is freestanding and self-anchored by the water pressure on flood control board and press it to the ground to increase its friction with the ground to make it more stable. Our flood control boards are suitable for use on flat ground, such as urban asphalt, pavement or cement floor, as long as the flood control board is prepared in advance, do a good job of flood risk management, you can keep your property safety at any time.



OPERATING PRINCIPLE

L-Type bookend Principle

The weight of water compressed at the bottom of the baffle and converts the weight into pressure. Even if the flood reaches the top of the board, it is still very stable and will not fall. The higher the water level, the stronger the retaining effect.

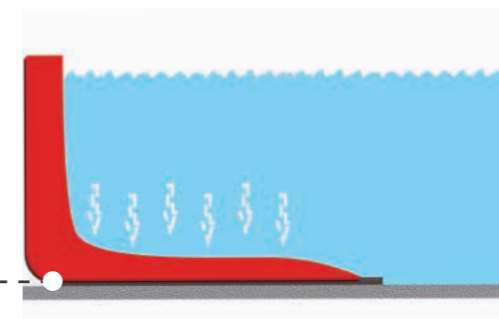

Memory rubber compound

The water-locking function of the rubber compound at the bottom of the flood board can prevent water penetration, anti-slip strip can increase the friction between the bottom and the ground.



DENILCO BOXWALL SPECIFICATION

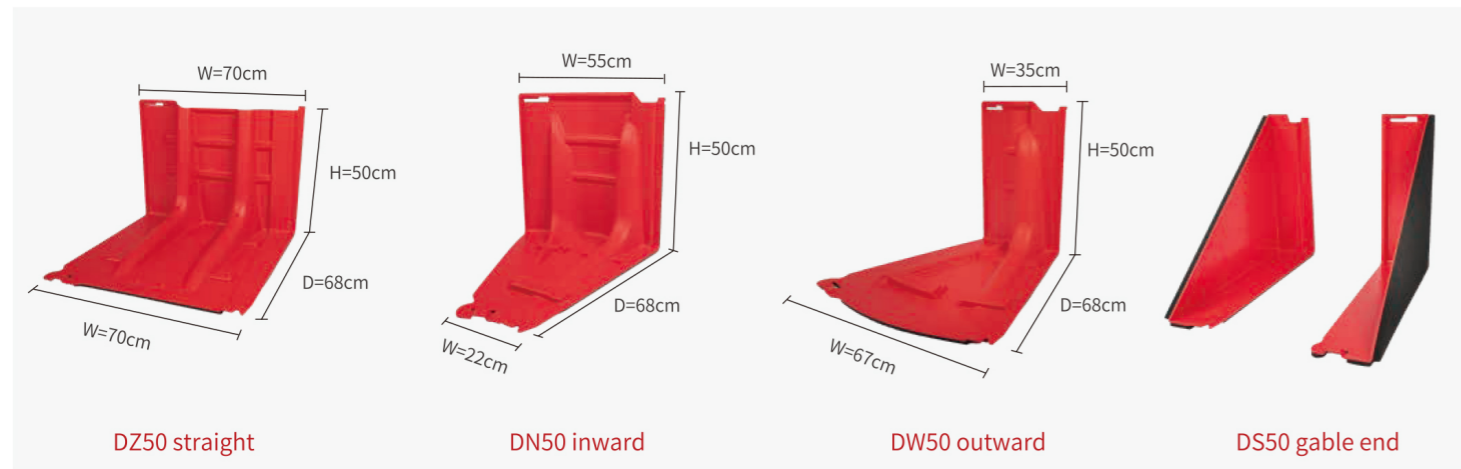

DZ50 straight DN50 inward DW50 outward DS50 gable end

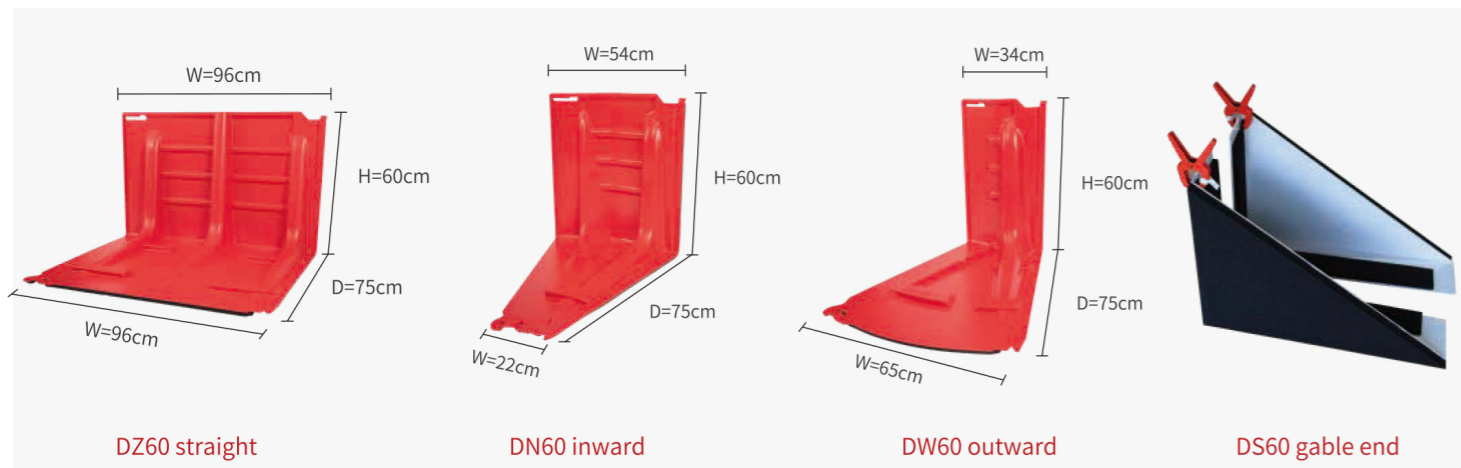

DZ60 straight DN60 inward DW60 outward DS60 gable end

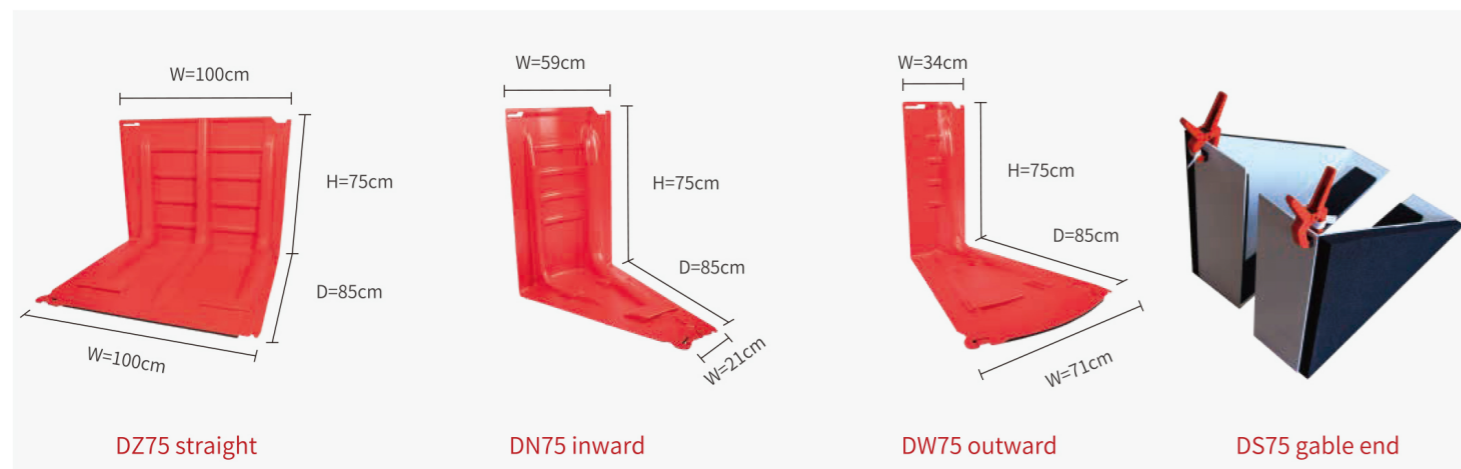

DZ75 straight DN75 inward DW75 outward DS75 gable end



DZ85 DN85 DW85 DS75 gable end

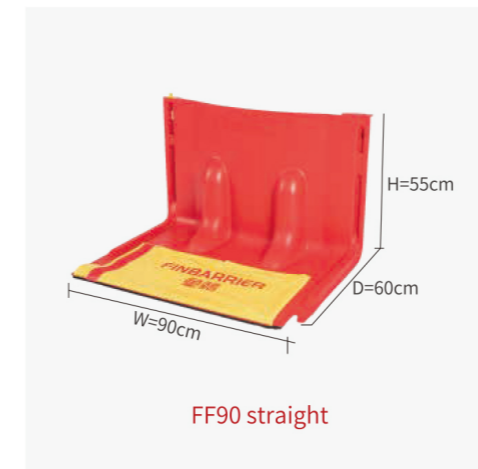

FF90 straight



FF210 straight

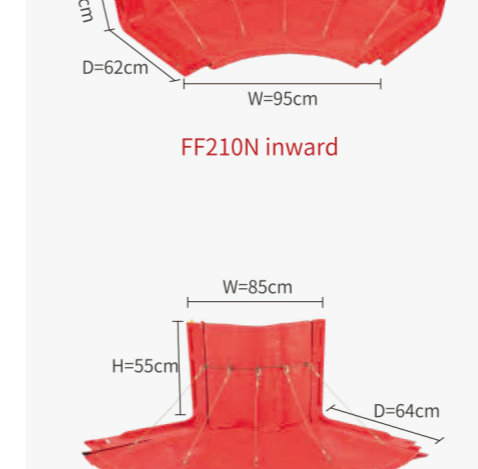

FF210N inward



FF90 gable end



FF96 with fin straight



FF96 without fin straight

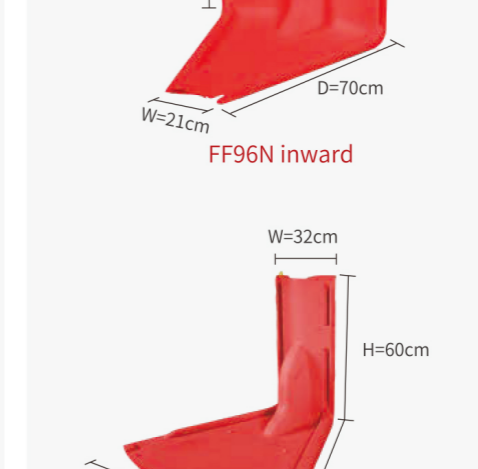

FF96N inward

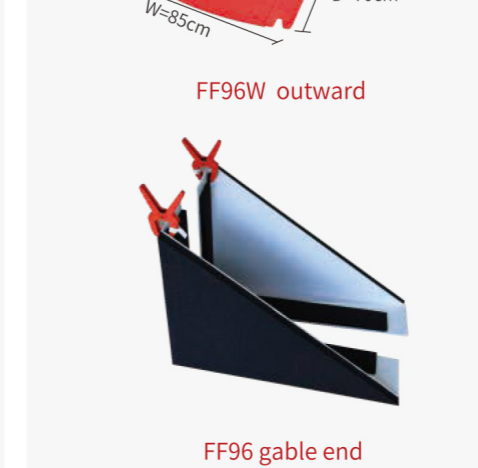

FF96W outward

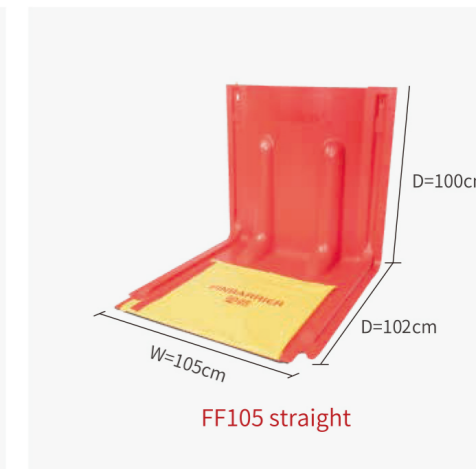

FF105 straight



FF220 straight

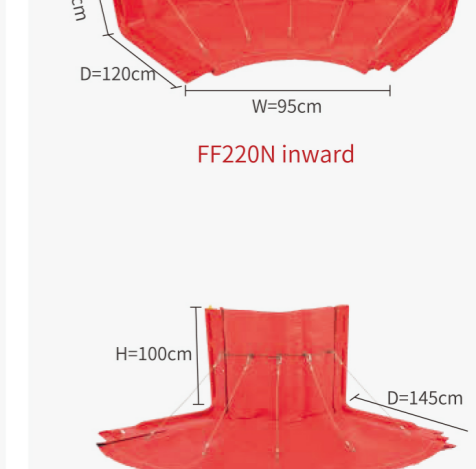

FF220N inward



FF220W outward

SPECIFICATIONS

Height	50cm	60cm	75cm
Weight	3.8kg±5%	7.2kg±5%	9.8kg±5%
Size	70.5cm*68cm*52.8cm	96cm*75cm*60cm	100cm*85cm*75cm
Average thickness	4mm	5mm	5mm
Installation speed	1 person can install 10 meters within 1 minute.		
Angle Bias	±3°adjustable		
Material	ABS		
Withstand temperature	-40°C to +95°C		
UV testing	irradiancy 0.76W/M2@340nm BPT:60°C ,8H (refer to ASTM G154-2016)		

CASES

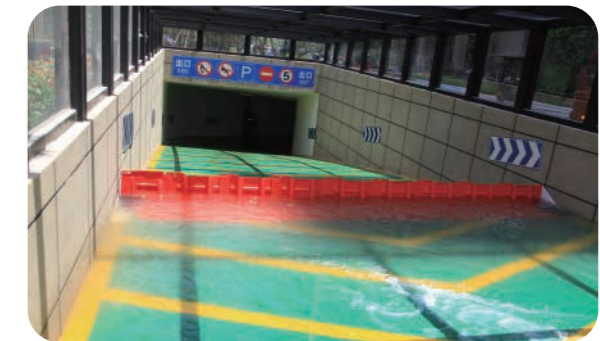
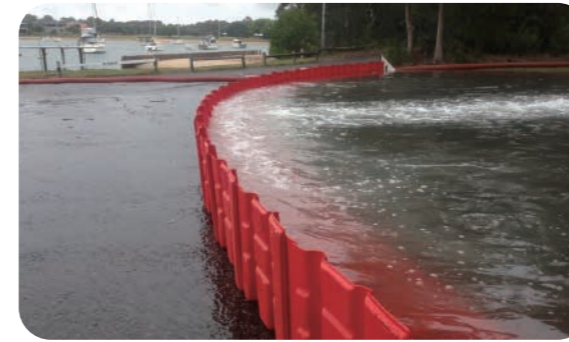
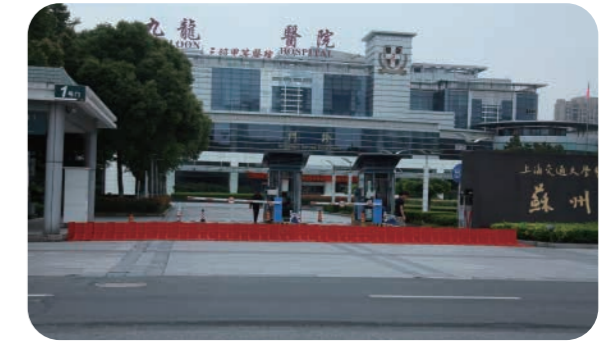

FINBARRIER EMERGENCY FLOOD CONTROL SCREEN

The new flood barrier employs a composite design featuring an 'L-shaped curved surface structure and flexible impermeability'. Manufactured from polymer materials, the barrier incorporates a spring-lock fastening system for installation. Its base is fitted with a removable impermeable pad, delivering enhanced waterproofing performance on uneven terrain.



PRODUCT STRUCTURAL CHARACTERISTICS

1. The arched water-retaining surface enhances product strength by 20%.
2. Previous models featured flat bottom panels suitable only for level surfaces, where uneven ground caused significant leakage. The new anti-seepage pad structure accommodates gravel, soil, and turf surfaces, substantially improving waterproofing.
3. The new spring-lock installation system offers easier assembly and more secure structural integrity.

Can be installed and used in conjunction with fish fin flood screens

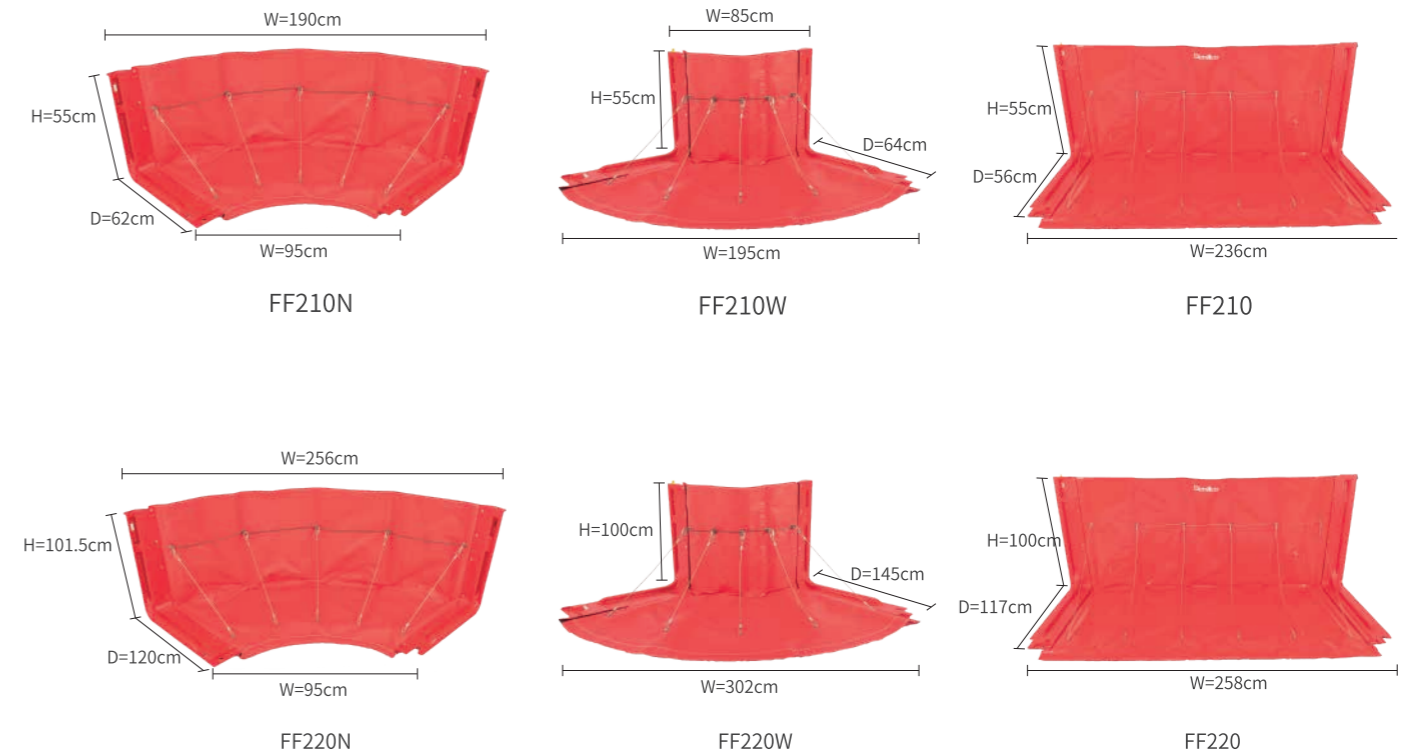

SELF-INFLATING SANDBAGS

Denilco self-inflating sandbags have a wide range of applications, can be used for the temporary flood control works, such as increasing the height of the dyke to stop the shortage, enclosing the water to prevent the overflow, engineering closure, the blockage of the ditch and the dark hole, reinforcement of flood control dams at any time, temporary flood prevention works such as urban water dam, street flood wall etc. It is only 275g before, after 2-3 minutes absorption can reach 20kgs, replace the usage of the soil to build a flood dam rapidly. To reduce the loss caused by the lack of soil in the emergency scene and the failure to take care in time.



DP400
without handle



DP436
with handle

ADVANTAGES OF SELF-INFLATING SANDBAGS



Denilco self-inflating sandbags have a wide range of applications, can be used for the temporary flood control works, such as increasing the height of the dyke to stop the shortage, enclosing the water to prevent the overflow, engineering closure, the blockage of the ditch and the dark hole, reinforcement of flood control dams at any time, temporary flood prevention works such as urban water dam, street flood wall etc. It is only 275g before, after 2-3 minutes absorption can reach 20kgs, replace the usage of the soil to build a flood dam rapidly. To reduce the loss caused by the lack of soil in the emergency scene and the failure to take care in time.

ADVANTAGES OF SELF-INFLATING SANDBAGS

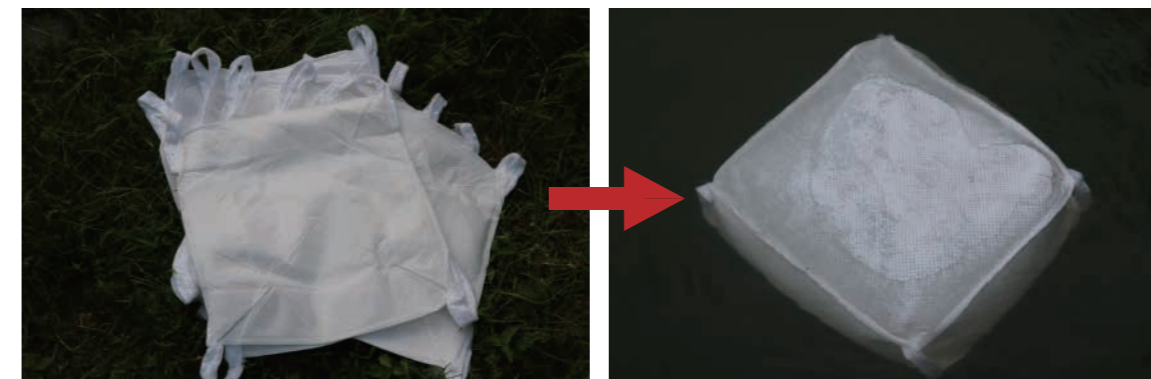

Before absorption
275g

After absorption
20kg



after absorption height reach 15cm



SPECIFICATIONS

Product: Non-woven fabric self-inflating sandbag	Article no.: DP400
Size: 400mm(length)*600mm(width)	Brand: DENILCO®
Material outside: Four in one ultrasonic polypropylene non-woven fabric	Color: White
Built-in material: hydrophilic nano-sap functional material is adopted as the main medium	
1. Expansion time: ≤3 minutes (water temperature environment ≥18°C)	
2. Compressive strength: ≥150 Kg	
3. Stacking height: ≥1.2m	
4. Sealing performance: there is no obvious leakage of resin debris before water absorption, and no overflow of contents after water absorption.	
5. Drop performance: free fall from 1 meter height to flat concrete floor without damage	
6. Thread body: 100% combed cotton thread	
7. Product weight: 0.27kg ±5% before water absorption and 20Kg ±5% after water absorption	
8. Expansion height: 15cm	
9. Use of environment: fresh water acid and alkali environment 8 > PH > 5	
10. Corrugated carton: moisture-proof plastic vacuum bag 50 pieces / carton plastic vacuum bag 50 pieces / carton	
11. Box gauge: 50*36*42cm	
12. Gross/net weight 15.5kg/14.4kg	
13. Storage condition: store in a dry and cool place	
14. Warranty period: 5 years	

ALUMINUM FLOOD BARRIER

- Plank and post material is 6063-T5 aluminum alloy, with rubber EPDM for sealing, and accessories to install.
- Aluminum wall thickness: 2mm. Height of each aluminum plank is 18cm, seal is 0.5cm. Total height is multiples of 18.5cm plus 4cm.
- Posts are installed at both ends, can be inside mount, or outside mount.
- Unlimited opening width. When opening width is $\geq 4m$, we'll split and add center post.
- Corner post available to make 90 degree turn.
- Easy and fast to install.

ALUMINUM FLOOD BARRIERS IN 2 COLORS



EPDM rubber seal under each aluminum planks.

INSIDE MOUNT OR OUTSIDE MOUNT

Aluminum flood barriers can also be one side inside mount, another side outside mount.

Inside mount.

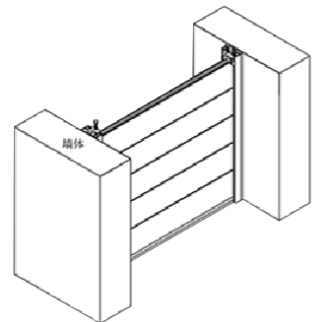

Outside mount, add 8cm at each side.

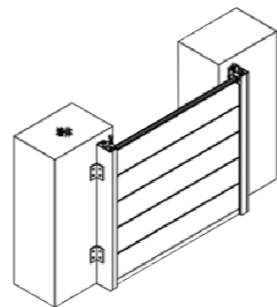

UNLIMITED OPENING WITH CENTER POSTS

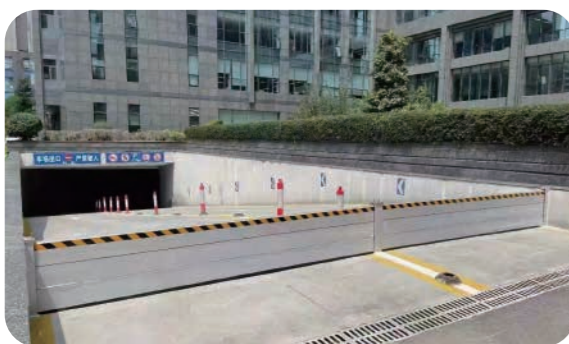

Aluminum flood barrier with corner posts

For higher barriers, plank support can be applied.

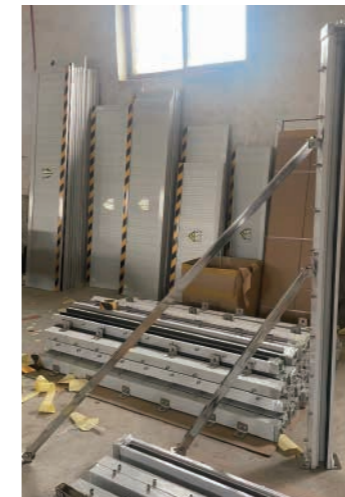

2 or 3 pcs of support braces can be applied on high center post.



Aluminum flood barrier with base plate for center post

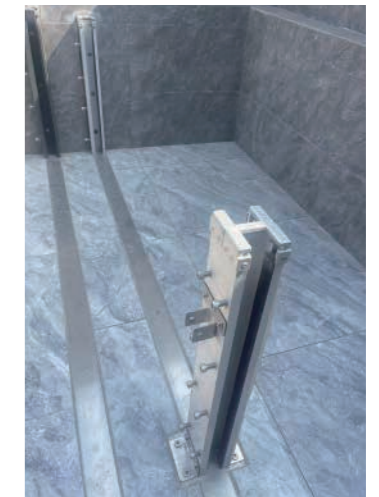

304 stainless steel base plate under aluminum flood barrier.

PACKING



Flood Prevention Pump With Huge Flow



INFLATING FLOOD TUBE

Denilco inflating tube is a temporary flood barrier composed of air inflated tubes connected together, they are suitable for asphalt, grasslands and even gravel pavement, especially for flood protection in coastal, agriculture, forestry, fishery, lakeside river, even low-lying areas can reach a good performance.



OPERATING PRINCIPLE

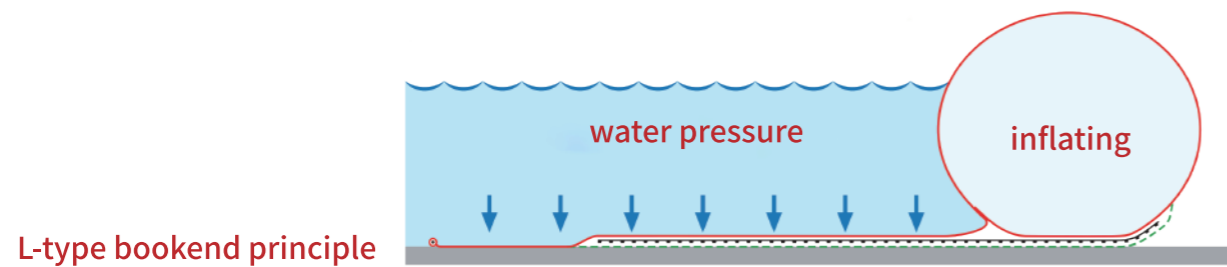

The weight of water compressed at the skirt of the tube and converts the weight into pressure. Increase the friction with the ground and force the skirt stick to the ground. The higher the water level, the stronger the retaining effect.

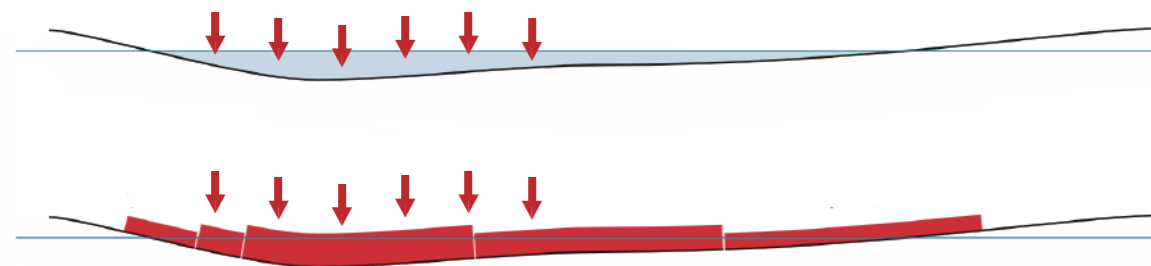

We can combine different type of flood tubes to reach a good flood protection in the uneven area

INSTALLATION METHOD



Lay out the flood tube on the ground



Use pump to inflate the tube

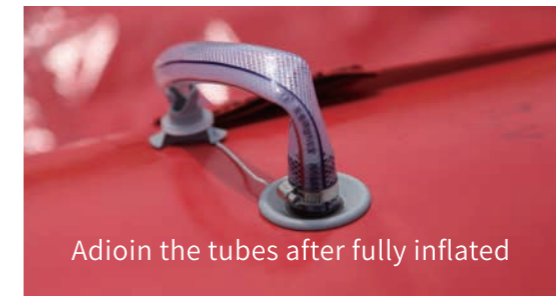

Join the tubes after fully inflated

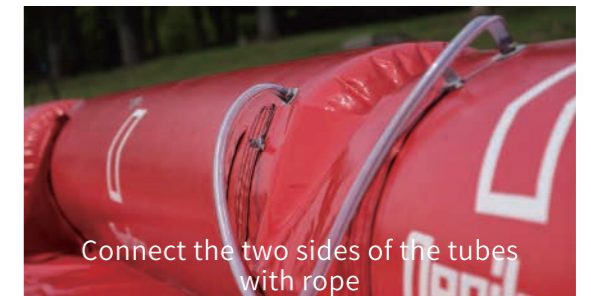

Connect the two sides of the tubes with rope



Completely join the two tubes with splice cloth from rear to front

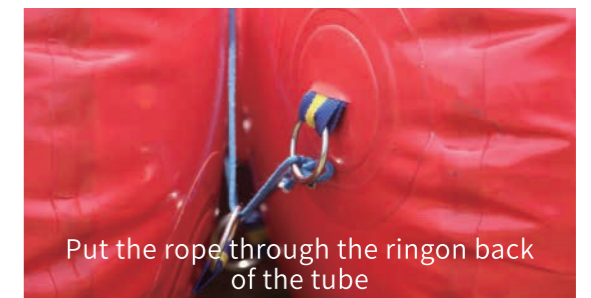

Put the rope through the ring on back of the tube



Fix the rope by nail



Put the nail through the hole in front of the tube (put sandbags or soil on the yellow area will be better)

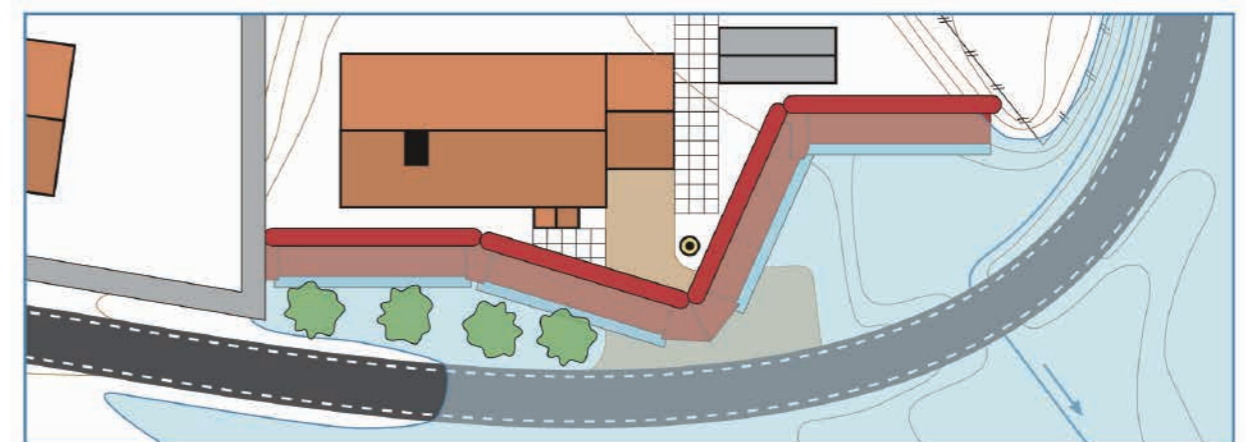

Customize the flood tubes according to the actual sites.

SANITARY SEWER OVERFLOW STOP

Denilco Sanitary Sewer Overflow stop(SSOS), is developed to face the sewer overflow during rainy seasons. Manhole covers often washed away during flash flood, which leads to a large amount of sewage gushing out, vehicles can not pass through, people are in danger of fall off. Sanitary Sewer Overflow Stop take advantage of the water pressure to fix the bottom, retain water to reach a balance to control the sewer overflow, ensure traffic open and the safety of pedestrian.

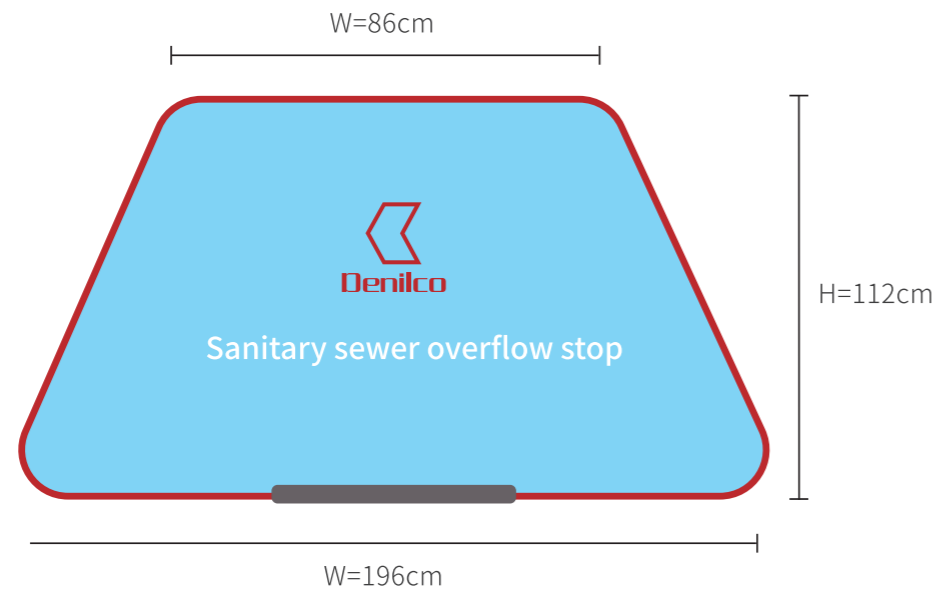

COMMON CAUSES OF SEWER OVERFLOW



- Sewer pipe blocked
- Excessive inflow of rain water into sewer during heavy rain
- Pump station lift failure or power supply failure
- The sewer pipeline is damaged, drainage capacity insufficient.

ADVANTAGES OF SANITARY SEWER OVERFLOW STOP



- Fast installation
- Light weight
- Storage convenience
- Long service life

INSTALLATION METHOD



First

Install the weight ring in the bottom of the SSOS



Second

Quickly install the SSOS in the overflow port



Third

When stored enough water and reached a balance it will reduce even close the overflow.

